



APPLICATIONS



DISH WASHER



KITCHEN SINK

SANIFAST



WMTS 106:2019  
Certificate No. 23048  
Manufacturer: SFA  
Brand: Saniflo

PRODUCT REFERENCE:  
SA221

## Sanifast®

The Sanifast® is a compact easy to service commercial grey water pump designed for light-medium usage. The unit is designed to receive and pump away waste water from a sink and dishwasher in busy commercial office kitchenettes with the option of "plug & play" Sanialarm Interlock connectivity.



### WHY CHOOSE THIS PRODUCT?

Ease of service design with no pipework connections on lid to hinder removal

Built in high level alarm

Plug and Play connectivity to optional external Sanialarm Interlock for water and power isolation

Large tank capacity

Factory pre-mounted non return valve (supplied)

High pumping performance

Integrated carbon filter and anti flood valve

### VERTICAL/HORIZONTAL PERFORMANCE

Increase size of horizontal run by one pipe size after 5m. All horizontal pipework requires a minimum of 1:100 fall.

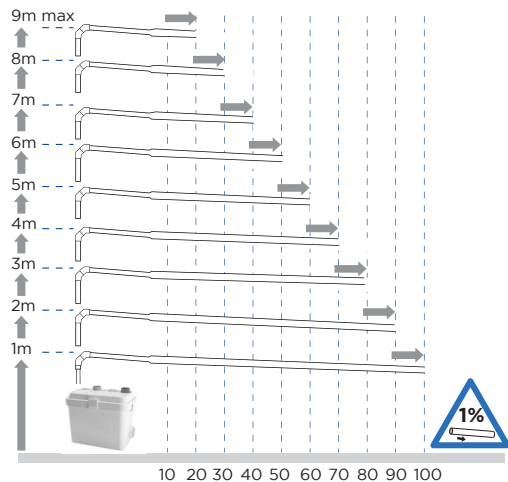

### TECHNICAL CHARACTERISTICS

Discharge Pipework	25 mm
Motor Power	850 Watts
Voltages	220-240 V/50 Hz
Working Waste Water Temp	40-75°C
Product Weight	6 kg
Overall Measurements	393 x 320 x 250 mm
Inlet Pipework	50 mm
IP Rating	IP44
Water Level Detection	Compact Float
Maximum Flow Rate	14m/h

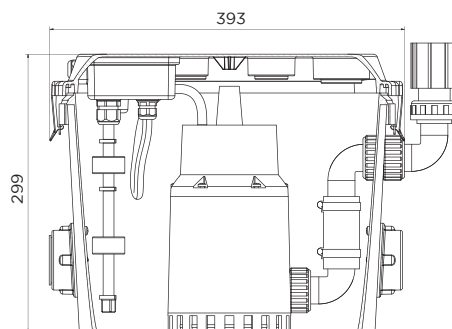

### FLOW RATE PERFORMANCE CHART

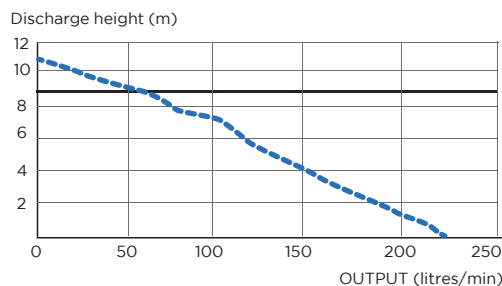

### Optional Sanialarm Interlock available

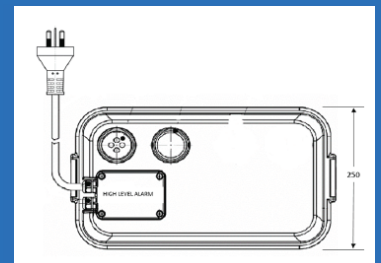

Shaking up water

Made in Germany to the highest standards, needs to be installed by a licensed plumber